

• () .
 • « »
 • : 10=46Nm.

• Mazda 3MPS (SP25) 2009- / Ford Focus III HB 2011-

• 12=79Nm

	1 .
12 1,25 75	2 .
10 35	4 .
12 1,25 /	2 .
10	4 .
10	4 .
12	4 .
VH0875	1 .
	1 .
1	1 .
	1 .
	1 .









Момент затяжки	
M6	9,5 Nm
M8	23 Nm
M10	46 Nm
M12	79 Nm
M14	125 Nm
M16	195 Nm
M10x1,25	49 Nm
M12x1,25	87 Nm
M12x1,5	83 Nm

	1 .
	1 .
	1 .

.....
.....	VIN
.....



462800, « - »
 18 ”
 : (35363) 7-05-06
 / : (35363) 7-13-20
 (495) 785-66-07
 www.bosal-autoflex.ru
 www.bosal.com

-	39 67 Mazda 3 HB+Sedan+MPS(SP25) Ford Focus III HB (DYB) Ford Grand C-max (DXA)  2003/2011 ⇨	 					D	
			1900	1200	75	16	7,21 кН.	Bosal Autoflex Russia BAR 28

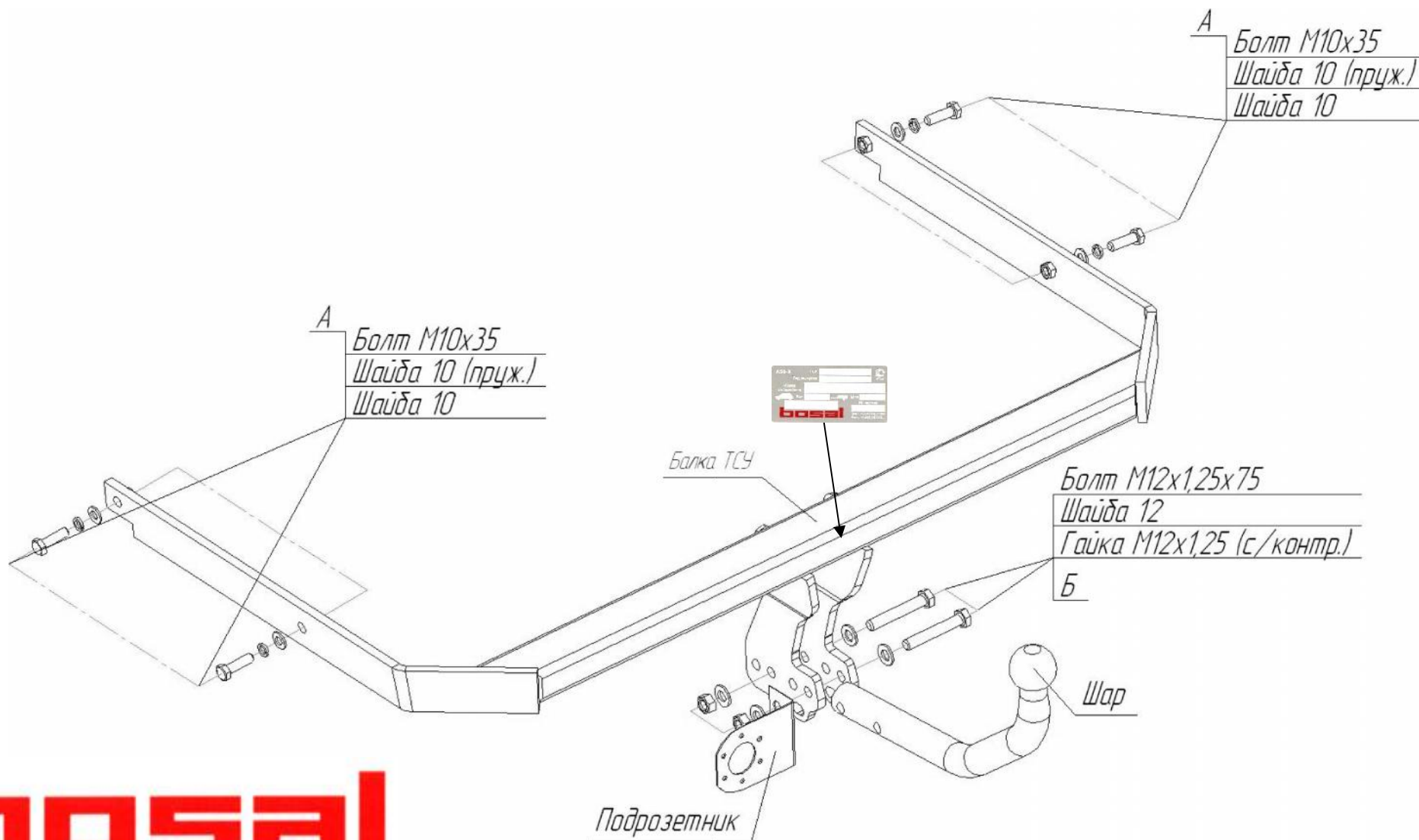

bosal