

14 (4 .)

	3 .
12 40	8 .
14 45	4 .
12 1,25 90	2 .
12 / .	8 .
12 1,25 / .	2 .
14 / .	4 .
12	16 .
14	8 .
	2 .
	2 .
VH 0140	1 .
	1 .
	1 .
	1 .
190	1 .
	1 .

<b>Момент затяжки</b>	
M6	9,5 Nm
M8	23 Nm
M10	46 Nm
M12	79 Nm
M14	125 Nm
M16	195 Nm
M10x1,25	49 Nm
M12x1,25	87 Nm
M12x1,5	83 Nm

	1 .
	1 .
	1 .
	1 .
	1 .







462800,

18

« . »  
 : (35363) 7-05-06  
 / : (35363) 7-13-20  
 (495) 799-13-46  
[www.bosal-autoflex.ru](http://www.bosal-autoflex.ru)  
[www.bosal.com](http://www.bosal.com)  
[info@bosal-autoflex.ru](mailto:info@bosal-autoflex.ru)



.....	.....
.....	VIN .....
.....	.....

	<p>56 08  <b>ГАЗ-3302</b>  <b>“Газель”</b>   1995 →</p>		 3500	 1400	 75	D 15,8	D 9,80 кН.	 Bosal Autoflex Russia BAR 28
--	--	---	---	---	---	-----------	------------------	--

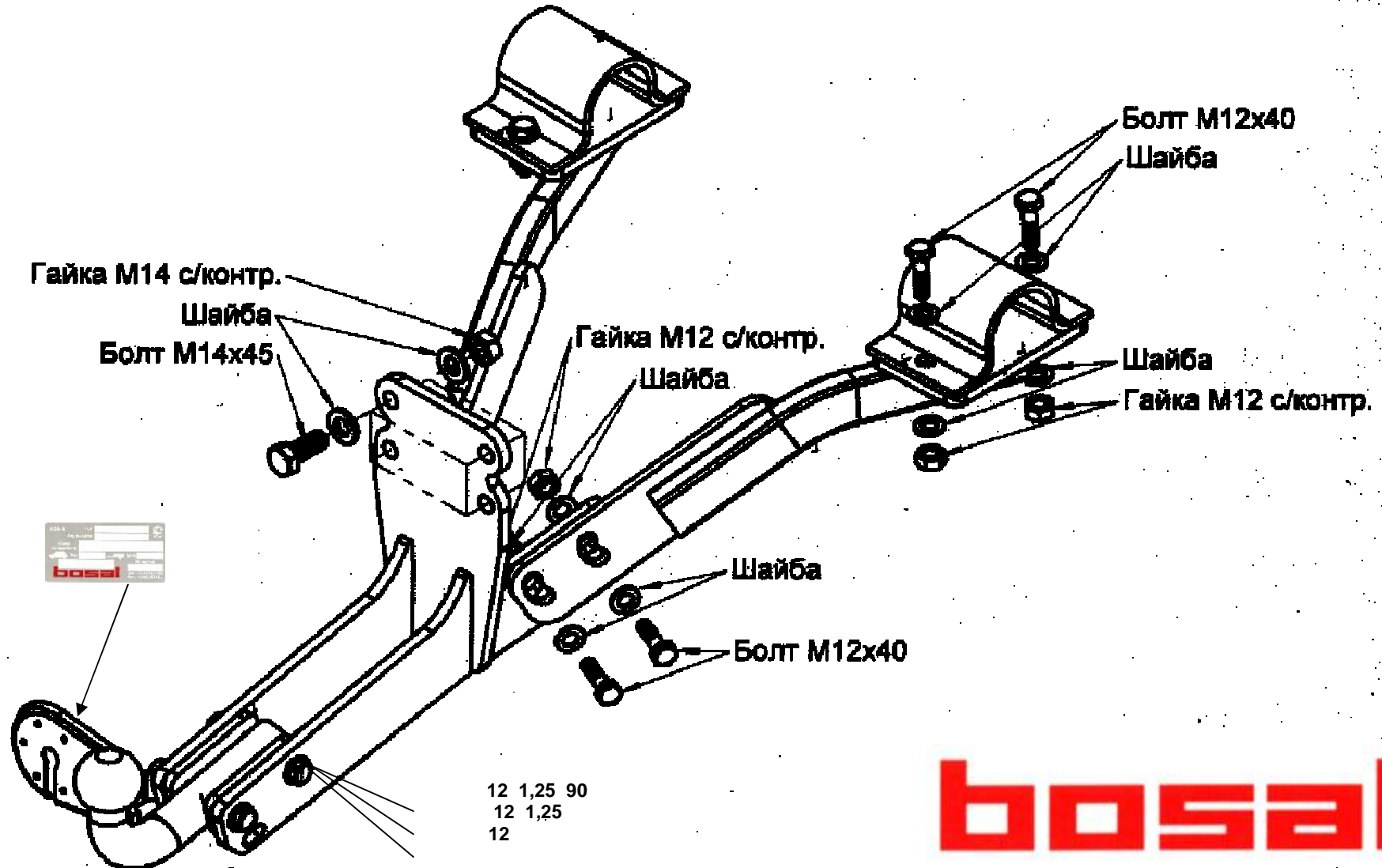

**bosal**